

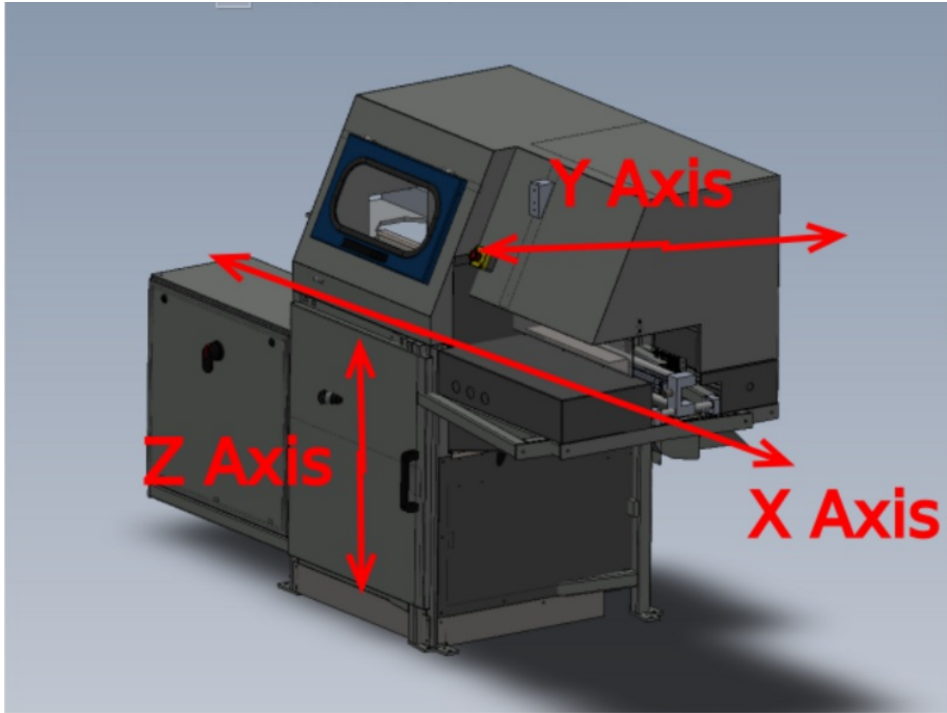

Fichier:ZX5 Production R0015040 Module F to R0015001B Module E alignment Screenshot 2023-12-20 133335.png



Size of this preview:800 × 599 pixels
Original file (832 × 623 pixels, file size: 190 KB, MIME type: image/png)
ZX5_Production_R0015040_Module_F_to_R0015001B_Module_E_alignment_Screenshot_2023-12-20_133335

File history

Click on a date/time to view the file as it appeared at that time.

	Date/Time	Thumbnail	Dimensions	User	Comment
current	14:33, 20 December 2023		832 × 623 (190 KB)	Gareth Green (talk contribs)	ZX5_Production_R0015040_Module_F_to_R0015001B_Module_E_alignment_Screenshot_2023-12-20_133335

You cannot overwrite this file.

File usage

The following page links to this file:

ZX5 Production R0015040 Module F to R0015001B Module E alignment

Metadata

This file contains additional information, probably added from the digital camera or scanner used to create or digitize it. If the file has been modified from its original state, some details may not fully reflect the modified file.

Horizontal resolution	37.79 dpc
Vertical resolution	37.79 dpc