

# Fichier:Saw machining centre alignment and level check points Screenshot 2023-11-10 130640.png

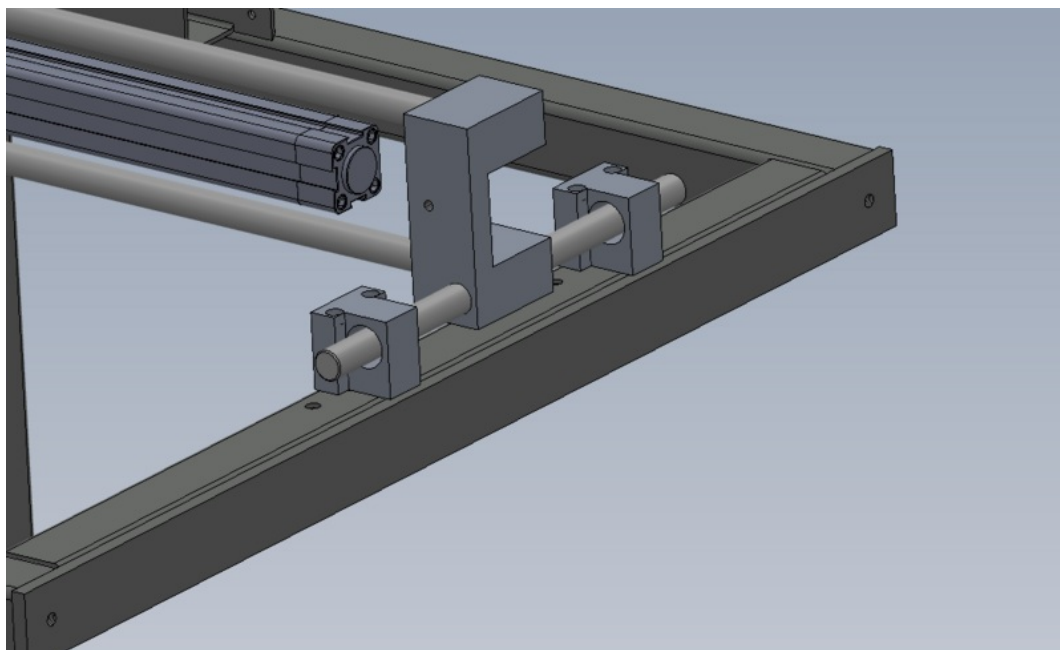

Size of this preview:800 × 487 pixels.

Original file (1,025 × 624 pixels, file size: 52 KB, MIME type: image/png)

Saw\_machining\_centre\_alignment\_and\_level\_check\_points\_Screenshot\_2023-11-10\_130640

## File history

Click on a date/time to view the file as it appeared at that time.

	Date/Time	Thumbnail	Dimensions	User	Comment
current	<a href="#">15:06, 10 November 2023</a>		1,025 × 624 (52 KB)	Gareth Green (talk   contribs)	Saw_machining_centre_alignment_and_level_check_points_Screenshot_2023-11-10_130640

You cannot overwrite this file.

## File usage

The following page links to this file:

[Saw machining centre alignment and level check points](#)

## Metadata

This file contains additional information, probably added from the digital camera or scanner used to create or digitize it. If the file has been modified from its original state, some details may not fully reflect the modified file.

Horizontal resolution	37.79 dpc
Vertical resolution	37.79 dpc