

# Fichier:R0015275 Fit shafts and pinions Screenshot 2023-07-06 130432.png

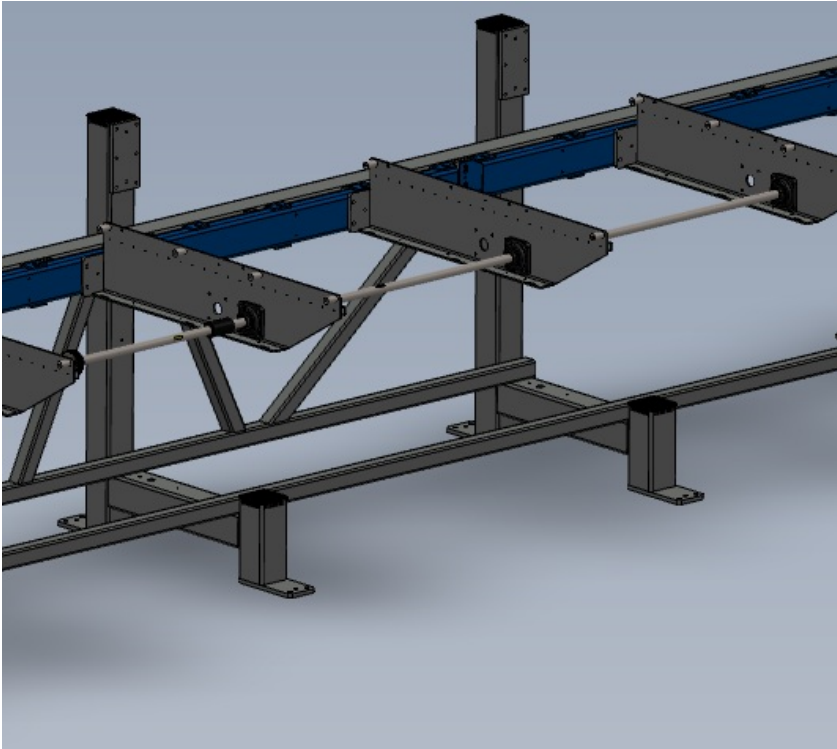

No higher resolution available.

R0015275\_Fit\_shafts\_and\_pinions\_Screenshot\_2023-07-06\_130432.png (534 × 475 pixels, file size: 79 KB, MIME type: image/png)

R0015275\_Fit\_shafts\_and\_pinions\_Screenshot\_2023-07-06\_130432

## File history

Click on a date/time to view the file as it appeared at that time.

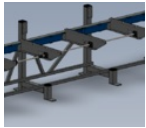
	Date/Time	Thumbnail	Dimensions	User	Comment
current	14:05, 6 July 2023		534 × 475 (79 KB)	Gareth Green (talk   contribs)	R0015275_Fit_shafts_and_pinions_Screenshot_2023-07-06_130432

You cannot overwrite this file.

## File usage

The following page links to this file:

R0015275 Fit shafts and pinions

## Metadata

This file contains additional information, probably added from the digital camera or scanner used to create or digitize it. If the file has been modified from its original state, some details may not fully reflect the modified file.

Horizontal resolution	37.79 dpc
Vertical resolution	37.79 dpc