

Fichier:R0015046 Bench Assemble Infeed Clamps Screenshot 2023-07-20 075749.png

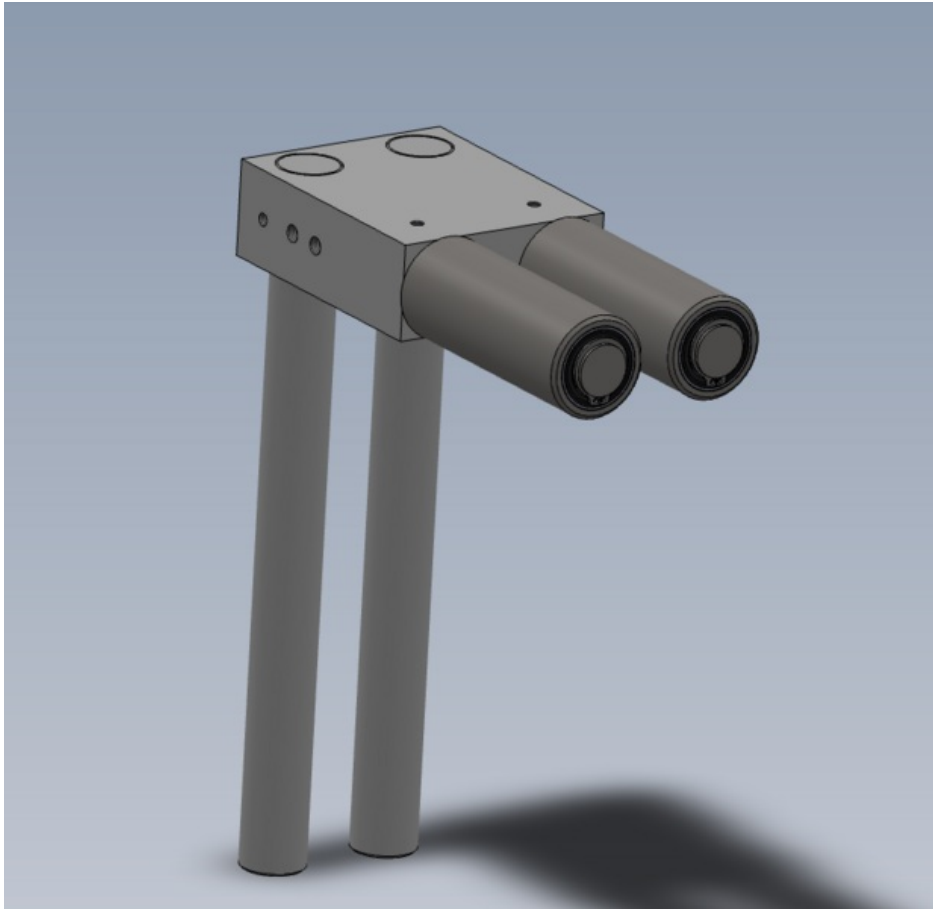

Size of this preview: 619 × 599 pixels.

Original file (813 × 787 pixels, file size: 86 KB, MIME type: image/png)

R0015046_Bench_Assemble_Infeed_Clamps_Screenshot_2023-07-20_075749

File history

Click on a date/time to view the file as it appeared at that time.

	Date/Time	Thumbnail	Dimensions	User	Comment
current	09:07, 20 July 2023		813 × 787 (86 KB)	Gareth Green (talk contribs)	R0015046_Bench_Assemble_Infeed_Clamps_Screenshot_2023-07-20_075749

You cannot overwrite this file.

File usage

The following page links to this file:

R0015046 Bench Assemble Infeed Clamps

Metadata

This file contains additional information, probably added from the digital camera or scanner used to create or digitize it. If the file has been modified from its original state, some details may not fully reflect the modified file.

Horizontal resolution	37.79 dpc
Vertical resolution	37.79 dpc