

Fichier:R0015041 Bench Assemble Top Hood Assembly Part 2 Screenshot 2024-06-26 093738.png

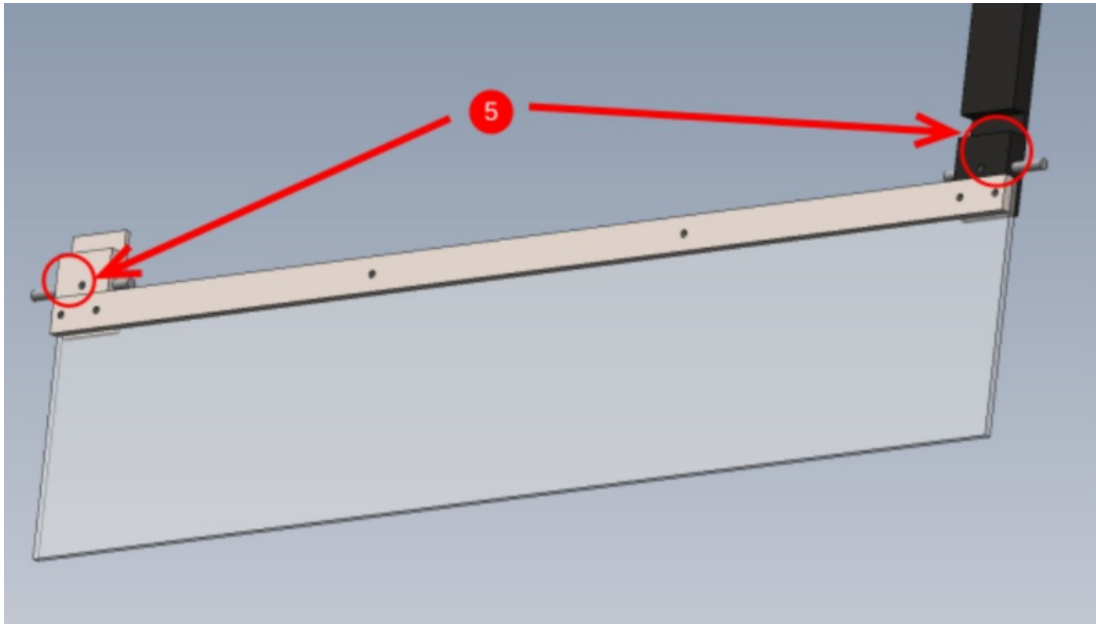

Size of this preview:800 × 450 pixels.

Original file (894 × 503 pixels, file size: 72 KB, MIME type: image/png)

R0015041_Bench_Assemble_Top_Hood_Assembly_Part_2_Screenshot_2024-06-26_093738

File history

Click on a date/time to view the file as it appeared at that time.

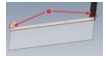
	Date/Time	Thumbnail	Dimensions	User	Comment
current	10:38, 26 June 2024		894 × 503 (72 KB)	Gareth Green (talk contribs)	R0015041_Bench_Assemble_Top_Hood_Assembly_Part_2_Screenshot_2024-06-26_093738

You cannot overwrite this file.

File usage

The following page links to this file:

R0015041 Bench Assemble Top Hood Assembly Part 2

Metadata

This file contains additional information, probably added from the digital camera or scanner used to create or digitize it. If the file has been modified from its original state, some details may not fully reflect the modified file.

Horizontal resolution	37.79 dpc
Vertical resolution	37.79 dpc