

Fichier:R0015028D Fit X axis gearbox and Motor Screenshot 2023-06-14 111407.png

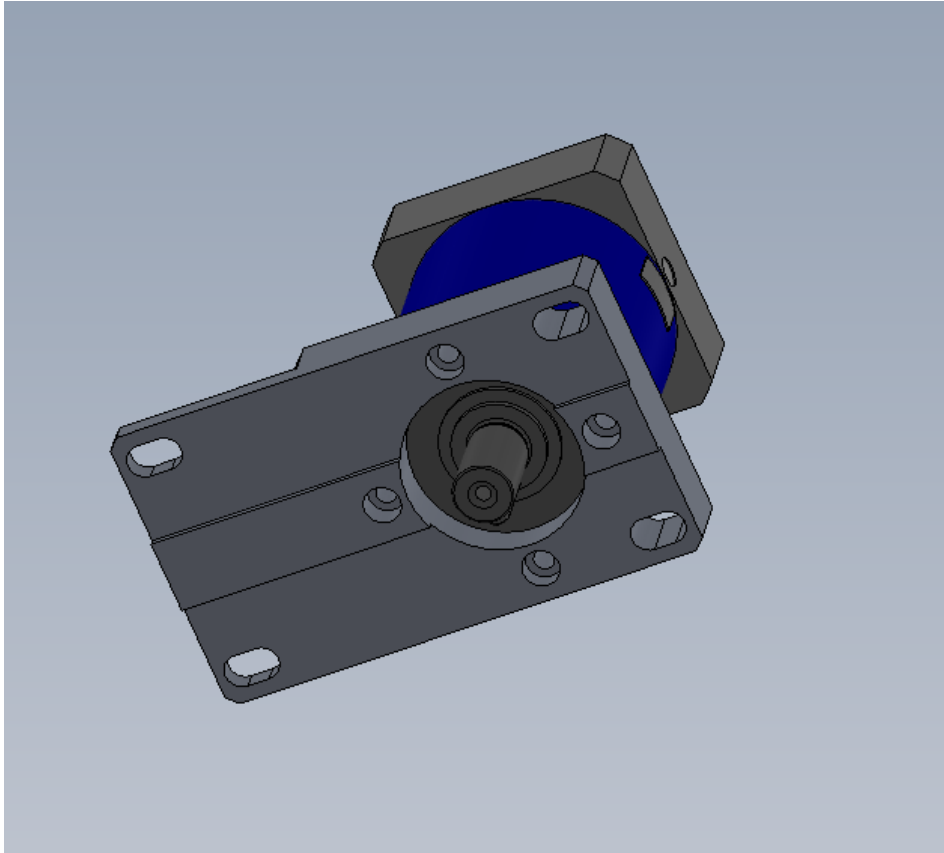

No higher resolution available.

R0015028D_Fit_X_axis_gearbox_and_Motor_Screenshot_2023-06-14_111407.png (628 × 567 pixels, file size: 22 KB, MIME type: image/png)

R0015028D_Fit_X_axis_gearbox_and_Motor_Screenshot_2023-06-14_111407

File history

Click on a date/time to view the file as it appeared at that time.

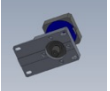
	Date/Time	Thumbnail	Dimensions	User	Comment
current	12:14, 14 June 2023		628 × 567 (22 KB)	Gareth Green (talk contribs)	R0015028D_Fit_X_axis_gearbox_and_Motor_Screenshot_2023-06-14_111407

You cannot overwrite this file.

File usage

The following page links to this file:

R0015247 Fit X axis gearbox and Motor

Metadata

This file contains additional information, probably added from the digital camera or scanner used to create or digitize it. If the file has been modified from its original state, some details may not fully reflect the modified file.

Horizontal resolution	37.79 dpc
Vertical resolution	37.79 dpc