

Fichier:R0000962E Bench assemble Y axis Components Screenshot 2023-07-18 094655.png

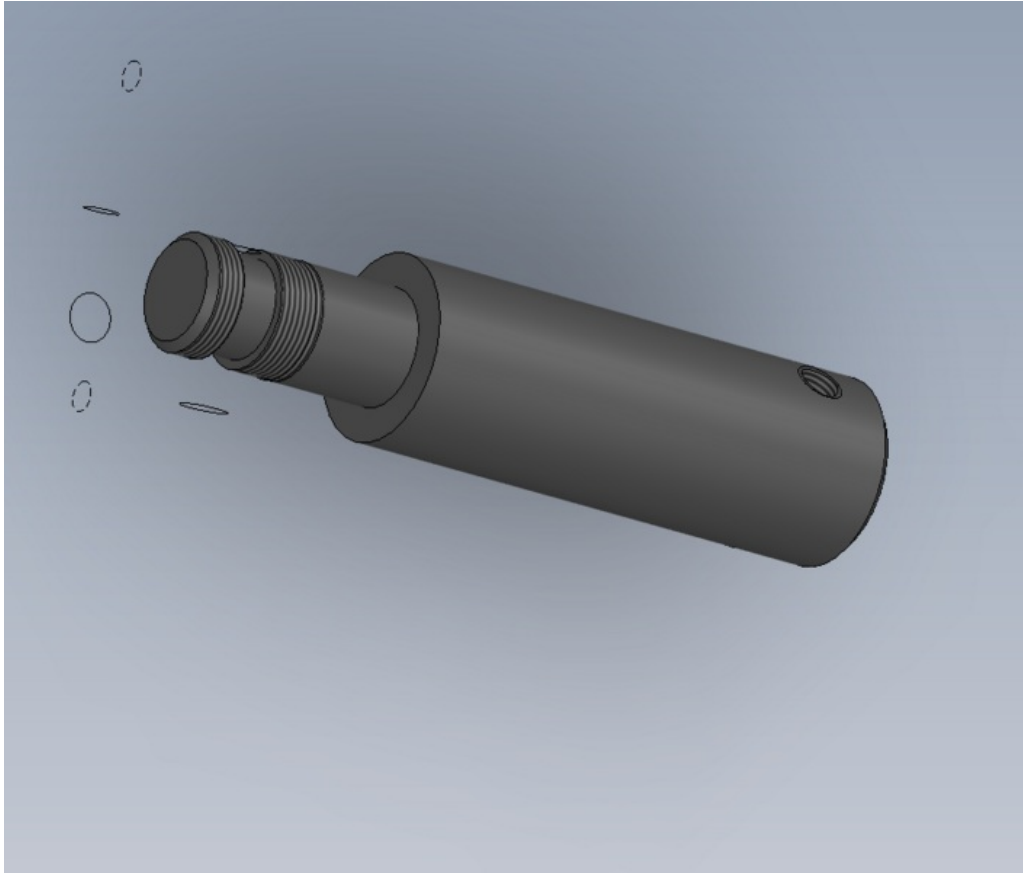

Size of this preview: 709 × 600 pixels.

Original file (863 × 730 pixels, file size: 125 KB, MIME type: image/png)

R0000962E_Bench_assemble_Y_axis_Components_Screenshot_2023-07-18_094655

File history

Click on a date/time to view the file as it appeared at that time.

	Date/Time	Thumbnail	Dimensions	User	Comment
current	10:47, 18 July 2023		863 × 730 (125 KB)	Gareth Green (talk contribs)	R0000962E_Bench_assemble_Y_axis_Components_Screenshot_2023-07-18_094655

You cannot overwrite this file.

File usage

The following 2 pages link to this file:

R0000962E Bench assemble Y axis Components

R0000963E Bench Assemble Z axis Components

Metadata

This file contains additional information, probably added from the digital camera or scanner used to create or digitize it. If the file has been modified from its original state, some details may not fully reflect the modified file.

Horizontal resolution	37.79 dpc
Vertical resolution	37.79 dpc